

# Analogue Instruments

High quality analogue instruments designed to measure an extensive range of electrical and electronic parameters. This comprehensive range offers DIN instruments, ANSI switchboard meters, panel indicators, sealed and ruggedised instruments, and complementary selector switches for line-to-line and line-to-neutral readings. Instruments are precision engineered and robust in design, ensuring accurate measurement and display in the most demanding of environments. All instruments are available in a range of styles, sizes and specifications to meet the exacting needs of your industry.

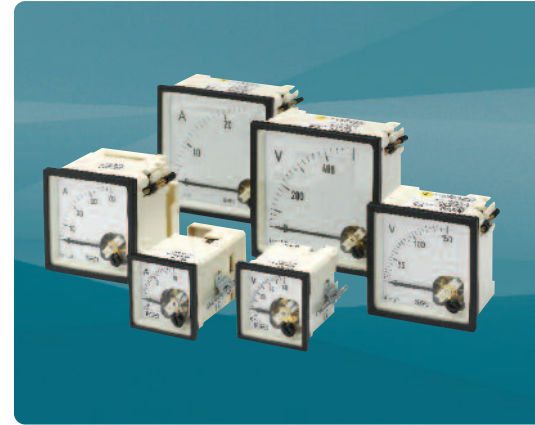

## Contents

### DIN Panel Meters

An extensive range of 48, 72, 96 and 144mm DIN style panel meters. Short-scale ammeters, voltmeters and frequency meters incorporate slide-in dials and terminal covers. Long-scale meters are also available. Meters for power or energy contain in-built transducers and can be customised to suit many different system configurations and ranges.

### Instrument Selector Switches

Panel mounted selector switches offering a 7-position voltmeter switch and a 4-position ammeter switch for reading line-to-line or line-to-neutral voltage and phase current.

### Saxon Series Panel Indicators

A range of 2½", 3½" and 4½" surface mount panel meters utilising pivot and jewel mechanisms and offering IP54 protection. The range offers iron vane and moving coil AC and DC ammeters and voltmeters, elapsed time and frequency meters. UL approvals.

### 016 Series Fiesta Panel Indicators

A robust range of short-scale 3½" surface mount panel meters offering IP55 protection and featuring wide-view contoured windows. The range offers iron vane and moving coil AC and DC ammeters and voltmeters, elapsed time and frequency meters. UL approvals.

### Challenger Analogue Panel Meters

Challenger analogue panel meters feature a detachable lower fascia plate, which allows either surface or window mounting. Meters use a high torque pivot and jewel movement.

### 078/080/087 Series Sealed and Ruggedised Indicators

Designed to comply with industrial, marine and military specifications, these 240° and 90° scale meters are resistant to extreme shock, vibration, temperature, dirt and humidity. The range offers a wide range of bezel sizes fitted with toughened glass.

## Page

2 - 21

22

23 - 24

25 - 27

28 - 32

33 - 37

## Features

- Extensive range
- Accurate measurement and display of electrical and electronic parameters
- Wide range of case styles and specifications
- Maximum reliability in harsh environments

## Benefits

- Low cost
- Local indication
- Ease of installation
- Minimal training
- Low maintenance
- Reasonable accuracy

## Applications

- Switchgear
- Distribution systems
- Generator sets
- Control panels
- Energy management
- Building management
- Utility power monitoring
- Process control
- Motor control

## Approvals

- UL, CSA, ABS, LRS, BV

## Features

- A range of the most popular short-scale measuring instruments in 4 case sizes
- Shock resistant sprung pivot and jewel movement
- Terminal covers supplied as standard
- EMC hard frequency meters are fully EMC and LVD compliant
- 1/4" 'fast on' terminals available

## Benefits

- Low cost
- Local indication
- Ease of installation
- Minimal training
- Low maintenance
- Customised options and features

## Applications

- Switchgear
- Distribution systems
- Generator sets
- Control panels
- Energy management
- Building management
- Utility power monitoring
- Process control
- Motor control

## Approvals

- Lloyds:
- 03/00055 - Moving coil meters
- 03/00056 - Moving iron meters
- 03/00057 - Frequency meters

# DIN Panel Meters – Short scale

A range of 48, 72, 96 and 144mm DIN style panel meters measuring all electrical parameters and featuring moving coil or moving iron movements. All meters incorporate slide-in dials and terminal covers as standard. A range of customised options is available.

## Movements

### Moving Coil Meter

Centre cored, self shielding moving coil movement, using pivots, hairsprings and sprung jewels. Seven variations have been designed in movement ranges: all intermediate ranges are achieved by shunting the next lowest range. All DC voltmeters are 1000 ohms per volt, rectified product run at 900 ohms per volt, millivolt meters use the 5 milliamp movement.

### Moving Iron Meter

Clapper type repulsion design using pivots, hairsprings and jewel movements. The bottom jewel is oil filled to provide damping while the top is sprung for resilience. All voltmeters are manufactured with external voltage dropper resistors to substantially reduce the self heating effects.

### Frequency Meter

Meter uses a 100 microamp 4000 ohm movement driven by an EMC hard frequency conversion circuit.

### Dials, Scales and Pointers

Standard dials are white matt with black printed scales and bar knife-edge pointers. Black dials with white or yellow scales and pointers are also available. Interchangeable slide-in dials are used on the E242, E243, E244 and E246 90° moving iron, moving coil and frequency meter models.

General options include red supplementary pointers, red indexes (quadrant scales), red, green or blue lines, bands or segments, finely spaced divisions, multi-scales, special scales and captions to customer's requirements.

## Specifications

Type of instrument	Moving iron for current and voltage	Moving coil for current and voltage	Moving coil with rectifiers for current and voltage	Moving coil with built-in transducer for frequency measurement	Maximum demand indicators	Combined MDI with moving iron movement
Format	48 x 48mm 72 x 72mm 96 x 96mm 144 x 144mm	48 x 48mm 72 x 72mm 96 x 96mm 144 x 144mm	48 x 48mm 72 x 72mm 96 x 96mm 144 x 144mm	72 x 72mm 96 x 96mm 144 x 144mm	72 x 72mm 96 x 96mm	96 x 96mm
Movement type	Sprung pivot jewel with silicon oil damping	Sprung pivot jewel with eddy current damping	Sprung pivot jewel with eddy current damping	Sprung pivot jewel with eddy current damping	Sprung pivot jewel with silicon oil damping	Sprung pivot jewel with silicon oil damping
Burden	0.5VA-15A then 0.8VA voltmeters 4.5VA	See detailed specifications	See detailed specifications	See detailed specifications	2.5VA	3VA
Accuracy	1.5% to DIN43780	1.5% to DIN43780	2.5% to DIN43780	0.5% to DIN43780	3%	3% on MDI 1.5% ammeter
Input type	AC current or voltage	DC current or voltage	AC current or voltage	AC voltage	AC current	AC current
Measuring range	6-600V 100mA-100A 48mm only up to 40A	50mV-600V 100µA-40A, 44mm only 25A	15-600V 1mA-100mA and 1A & 5A	57.7V @ 45Hz 500V @ 44Hz	0-1/1.2A or 0-5/6A 8, 15 or 20 minute delays	1-6A 8, 15 or 20 minute delays 0-5A/6A instantaneous
Dielectric voltage withstand test	3kV AC	3kV AC	3kV AC	3kV AC	3kV AC	3kV AC

## General Specifications

Performance:	BSEN60051
Measuring ranges:	DIN43701
Accuracy overload:	BSEN60051
Dimensions:	DIN43700
Scale marking generally to:	DIN43802
Magnetic influence:	BSEN60051
Safety:	BSEN61010-1
Terminals:	Clamp strap M4 for up to 25A. Clamp strap M8 for over 25A 1/4" spade terminals available for models E243 and E244
Humidity range:	Up to 95% RH (non condensing)
Test voltage @50Hz:	3kV RMS for 1 minute
Ammeter ranges:	1.0/1.2/1.5/2.5/5/6 and decade multiples thereof
Overload AC current:	x 1.2 continuous x 10 for 5 seconds
AC voltage and frequency:	x 1.2 continuous x 2 for 5 seconds
Standard calibration:	23°C. Calibration at other temperatures available on request
Operating temperature:	-20°C to +60°C
Damping time:	Less than 3 seconds
Enclosure code:	IP52 as standard IP54 on request
Case and base:	Grade UL94V0
Case:	Dimensions and panel cut out conform to IEC473, DIN43700. Case made from glass filled polycarbonate self-extinguishing and non drip in accordance with UL94V-O
Bezel:	Slim-line DIN43802, black as standard
Bezel window:	Standard sheet glass, with zero adjusters where appropriate. Non reflecting glass or polycarbonate shatterproof windows are available
Installation:	Installations in switchboard panel or mosaic arrangement on equipment or machine with a panel thickness of up to 40mm in a horizontal or vertical plane
Fixing on panel:	Swivel captive fasteners, which can be fixed at either corner
Mounting position:	Normal vertical mounting or as indicated on the scale in accordance with DIN16257. A deviation of $\pm 15^\circ$ is permissible
Insulation group:	Insulation resistance more than $5M\Omega @ 500V$
Environmental:	Measurement category III IEC 1010-1 Pollution degree 2 IEC 1010-1 Electrical rating 600V RMS (920V peak)
Approvals:	EMC, LVD and Lloyds



## DIN16257 symbol meaning for calibration position



Inclination of dial surface.

Required orientation must always be stated when ordering if other than vertical mounting is required.

## Dimensions

Moving coil measuring range		Moving iron measuring range	
6-60A	C=67mm	0-30A	C=64mm
>60A	C=78mm	>30A	C=67mm

## Max. panel thickness = 40mm

D	A	B
48 x 48	45 x 45	4
72 x 72	68 x 68	4
96 x 96	92 x 92	4
144 x 144	138 x 138	4

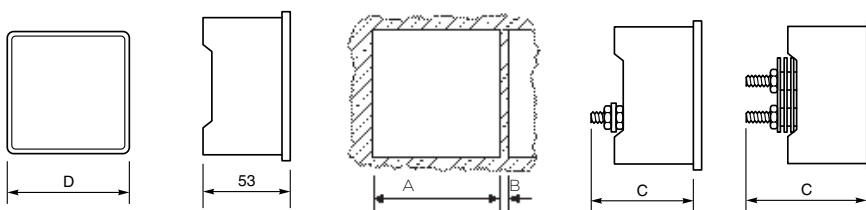

## Moving Iron AC Ammeters and Voltmeters

Designed to measure AC current or voltage, these meters indicate true RMS values and are substantially independent of system waveform. Scales are calibrated down to 20%, and ammeters can have overload scales of x2, x3, x5 or x6 for motor start duty. Ammeters can be supplied for use with -/1A or -/5A current transformers, whilst voltmeters can be scaled for use with voltage transformers. Meters can be used to measure DC at reduced accuracy.



### Connections

#### AC Ammeter

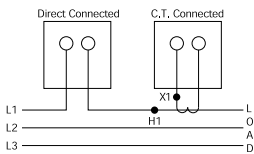
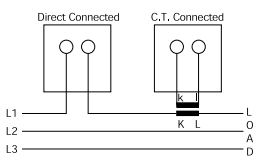

#### AC Voltmeter

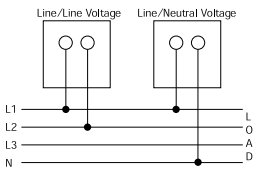

### Specifications

Accuracy:	Class 1.5
Frequency:	50 or 60Hz, (400Hz on request)
Burden at 50Hz:	Ammeters: 0.5VA voltmeters: Up to 4.5VA maximum
Ratings:	Ammeters: 0.5-100A AC direct connected (40A for E242-75A and E246-02A) Maximum system voltage 600V AC Low load/high middle, maximum 10A
Voltmeters:	6-600V

### Product Codes

Bezel size mm	48	72	96	144
Scale length mm	42	65	94	145
AC ammeter	E242-75A	E243-02A	E244-02A	E246-02A
x2 overload ammeter	E242-752A	E243-022A	E244-022A	-
x3 overload ammeter	E242-753A	E243-023A	E244-023A	-
x5 overload ammeter	E242-755A	E243-025A	E244-025A	-
x6 overload ammeter	E242-756A	E243-026A	E244-026A	-
AC voltmeter	E242-75V	E243-02V	E244-02V	E246-02V

## Frequency Meters

Frequency meters use an integral electronic converter and a moving coil indicator. These easy to read meters have accuracy Class 0.5.



### Connections

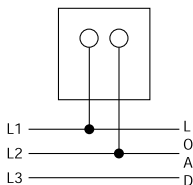

### Specifications

Ratings:	100-125V AC 200-250V AC 380-440V AC* 500V AC* *Use E242-89A and 253-THZ in place of E242-41S for voltages over 380V Models available for use with VTs
Frequency:	0.5%: 45/55Hz, 55/65Hz, 45/65Hz, 360/440Hz
Burden:	4VA maximum

### Product Codes

Bezel size mm	48	72	96
Scale length mm	42	65	94
<b>Product codes</b>	E242-41S	E243-41S	E244-41S

## Maximum Demand Indicators

The thermal/time characteristics of MDI meters monitor the most economic use of cable, fusegear and transformers. The directly heated bimetal element indicates mean RMS current over 8, 15, or 20 minutes, and a red slave pointer shows the highest value reached. The reset knob is wire sealable. Scales are calibrated to match the CT primary plus 20% overload. End values are selected from: 1.2, 1.8, 2.4, 3, 3.6, 4.8, 6, 7.2, 9 amps and their multiples of 10 and 100.

### Specifications

Accuracy:	Class 3
Options:	5A for use with separate CT 5/5A saturating CT 1/5A saturating CT
Burden at 50 Hz:	MDI - 2.5VA, CT - 2VA
Overload withstand:	Standard: 5 x FL for 5 seconds, 10 x FL for 1 second. With saturating CT: 10 x FL for 3 seconds, 20 x FL for 1 second
Frequency:	50/60Hz

### Product Codes

Bezel size mm	72	96
Scale length mm*	65	94

#### Product codes

##### 8 minute time lag

without limiting CT for use with 5A CT	E243-16B	E244-16B
--	----------	----------

##### 15 minute time lag

without limiting CT for use with 5A CT	E243-16A	E244-16A
--	----------	----------

##### 20 minute time lag

without limiting CT for use with 5A CT	E243-16J	E244-16J
--	----------	----------

\* Scaled 0/100/120% of CT primary value.

## Combined AC Ammeter and Maximum Demand Indicator

Where measurement of instantaneous and maximum demand currents are required, these instruments combine both movements in one case. The meter can also replace an existing AC ammeter. Meets the same specifications listed above.

### Specifications

Accuracy:	Moving iron ammeter: Class 1.5 MDI: Class 3
Burden at 50Hz:	MI - 0.5VA, MDI - 2.5VA saturating CT - 2VA

### Product Codes

Bezel size mm	72	96
Scale length mm*	65	94

#### Product codes

##### 8 minute time lag

without limiting CT for use with 5A CT 3VA	-	E244-16Q
--	---	----------

##### 15 minute time lag

without limiting CT for use with 5A CT 3VA	E243-16C	E244-16C
--	----------	----------

##### 20 minute time lag

without limiting CT for use with 5A CT 3VA	-	E244-16H
--	---	----------

\* Scaled 0/100/120% of CT primary value.

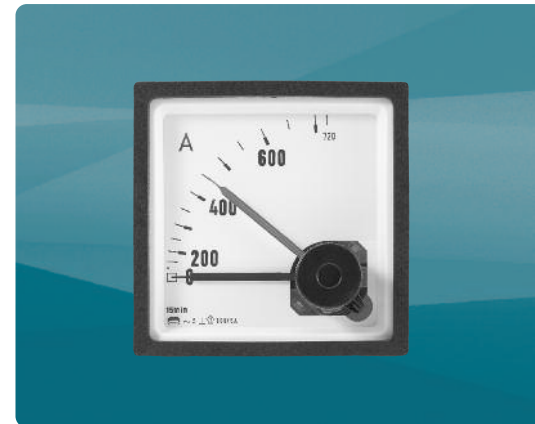

### Connections

#### Maximum Demand Indicators

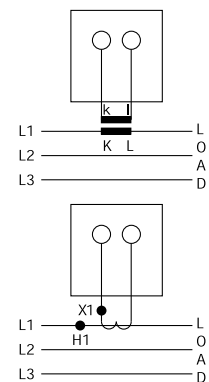

## Moving Coil DC Ammeters and Voltmeters

Moving coil meters are suitable for all DC systems. The linear scale is calibrated down to zero and the accuracy maintained down to 10%. High currents are measured with separate shunts and suitably scaled indicators. Suppressed, centre and offset zero models are available.



### Connections

#### DC Voltmeter

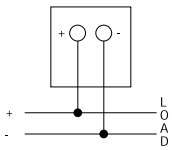

#### DC Ammeter

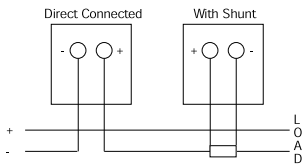

### Specifications

Accuracy:	Class 1.5
Ratings:	Ammeters: 100 $\mu$ A-25A 4/20mA suppressed zero 40A for model E242, E243 and E244 up to 100A Volts: 50mV-600V 1/5V suppressed zero 50, 60, 75, 100, 150mV for use with shunts
Impedance:	Ammeters: 75mV internal shunt above 60mA Volts: 1000 $\Omega$ /V above 1V

### Product Codes

Bezel size mm	48	72	96	144
Scale length mm	42	65	94	145

#### Product codes

Ammeters	E242-89A	E243-01A	E244-01A	E246-01A
Ammeters suppressed zero	E242-89R	E243-01R	E244-01R	E246-01R
Volts	E242-89V	E243-01V	E244-01V	E246-01V
Volts suppressed zero	E242-89S	E243-01S	E244-01S	E246-01S

## Moving Coil Rectified AC Ammeters and Voltmeters

For high frequency or linear full scale AC measurements, these instruments measure average values of sinusoidal waveforms and are scaled in RMS values. The high quality silicon bridge rectifier gives a linear scale down to near zero, where some compression occurs.



### Connections

#### AC Ammeter

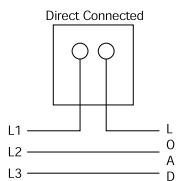

#### AC Voltmeter

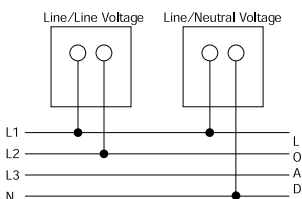

### Specifications

Accuracy:	1.5% ES
Ratings:	Ammeters: 250 $\mu$ A-1A AC Over 1A via CTs
Volts:	15 - 600V AC direct connected. models available for use with VTs
Frequency:	50/60Hz, (Single frequencies 25Hz - 3kHz on request)

### Product Codes

Bezel size mm	48	72	96	144
Scale length mm	42	65	94	145

#### Product codes

Ammeters	E242-89B	E243-01B	E244-01B	E246-01B
Volts	E242-89W	E243-01W	E244-01W	E246-01W

## Process Indicators

Meters are used to check process functions locally or remotely at centralised controls. These moving coil instruments offer a wide variety of electrical and mechanical readouts and are operated by transducer, tachogenerator, thermocouple, resistance bulb or other DC analogue signals. Suppressed, centre and offset zero models are available on request.

### Specifications

Accuracy:	Class 1.5
Ratings:	1, 2, 5, 10, 20mA 4/20mA suppressed zero

### Product Codes

Bezel size mm	48	72	96	144
Scale length mm	42	65	94	145

#### Product codes

AC current	E242-89A	E243-01A	E244-01A	E246-01A
AC voltage	E242-89V	E243-01V	E244-01V	E246-01V
Phase angle	-	E243-014	E244-014	-
Watts	-	E243-015	E244-015	-
VAR	-	E243-016	E244-016	-
VA	-	E243-017	E244-017	-



### Connections

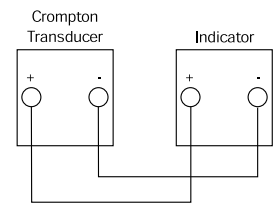



## Moving Iron AC Ammeters and Voltmeters with Selector Switch

These 96mm and 72mm units offer Class 1.5 true RMS measurement of three-phase AC voltage or current with various switch notation options. The integral selector switch eliminates the necessity for a separate selector switch, saving valuable panel space and providing installation benefits. Both ammeters and voltmeters feature a slide-in dial, scaled for VT or CT values to suit application primary values.

These robust moving iron meters incorporate a clapper type repulsion design which utilises a pivot, hairspring and jewel movement. The bottom jewel is oil filled to provide damping while the top is sprung for resilience. Voltmeters are manufactured with internal voltage dropper resistors.

### Features

- Integral selector switch
- True RMS measurement
- Slide-in dials
- Scaled for customer VT or CT primary values
- DIN 72 and DIN 96 models
- Terminal cover as standard
- Shock resistant sprung pivot and jewel movement
- x2 overload ammeters

### Benefits

- Space and time saving
- Competitive cost
- Local indication
- Ease of installation
- Low maintenance
- Customised options and features

### Applications

- Switchgear
- Distribution systems
- Generator sets
- Control panels
- Energy management
- Building management

### Compliant with

- IEC61010-1B2001, EMC and LVD

### Product Codes - AC Ammeters with Selector Switch

Code	Case size	Full scale deflection	Switch notation
E243-02E-G-LS**-C7-AMP3	72mm	0/5 A AC	OFF L1 L2 L3
E244-02E-G-LS**-C7-AMP3	96mm	0/5 A AC	OFF L1 L2 L3
E243-022E-G-LS**-C7-AMP3	72mm	0/5/10A AC	OFF L1 L2 L3
E244-022E-G-LS**-C7-AMP3	96mm	0/5/10A AC	OFF L1 L2 L3
E243-02E-G-LA**-C7-AMP3	72mm	0/1 A AC	OFF L1 L2 L3
E244-02E-G-LA**-C7-AMP3	96mm	0/1 A AC	OFF L1 L2 L3
E243-022E-G-LA**-C7-AMP3	72mm	0/1/2A AC	OFF L1 L2 L3
E244-022E-G-LA**-C7-AMP3	96mm	0/1/2A AC	OFF L1 L2 L3

\*\*Insert applicable CT primary value.

### Product Codes - AC Voltmeters with Selector Switch

Code	Case size	Full scale deflection	Switch notation	3-phase
E243-02Q-G-PM**-C7-SW6	72mm	0/120V AC	OFF L1L2 L2L3 L3L1	3W
E243-02Q-G-PZ**-C7-SW6	72mm	0/150V AC	OFF L1L2 L2L3 L3L1	3W
E243-02Q-G-PZ-PZ-C7-SW6	72mm	0/150V AC	OFF L1L2 L2L3 L3L1	3W
E243-02Q-G-RX-RX-C7-SW6	72mm	0/300V AC	OFF L1L2 L2L3 L3L1	3W
E243-02Q-G-SF-SF-C7-SW3	72mm	0/500V AC	L1L3 L1L2 L2L3 L3N L2N L1N	4W
E243-02Q-G-SJ-SJ-C7-SW3	72mm	0/600V AC	L1L3 L1L2 L2L3 L3N L2N L1N	4W
E244-02Q-G-PZ**-C7-SW6	96mm	0/150V AC	OFF L1L2 L2L3 L3L1	3W
E244-02Q-G-PZ-PZ-C7-SW6	96mm	0/150V AC	OFF L1L2 L2L3 L3L1	3W
E244-02Q-G-RX-RX-C7-SW6	96mm	0/300V AC	OFF L1L2 L2L3 L3L1	3W
E244-02Q-G-SF-SF-C7-SW3	96mm	0/500V AC	L1L3 L1L2 L2L3 L3N L2N L1N	4W
E244-02Q-G-SF-SF-C7-SW3	96mm	0/600V AC	L1L3 L1L2 L2L3 L3N L2N L1N	4W

\*\*Insert applicable VT primary and secondary value, e.g. 15kV/110V.

### Product Codes - Options

#### Description

Non reflecting glass window

Polycarbonate shatterproof window

Red supplementary pointer, externally adjustable

Red index mark (triangle)

Please state any required options at time of ordering.



## General Specifications

Accuracy:	1.5% of full scale deflection (FSD)
Input rating:	Ammeter: 1A, 5A 1/2A or 5/10A moving iron, direct connected Voltmeter: 120, 300, 500 and 600V AC
Frequency:	50 or 60Hz (400Hz on request)
Burden at 50Hz:	Ammeters: 0.5VA Voltmeters: 4-5VA max
Overload ammeter:	2 x In continuous for 2 minutes, 4 x In for 1 minute
Overload voltmeter:	1.2 x continuous 2 x for 5 seconds
Movement:	Moving iron shock resistant sprung pivot and jewel
Scale length:	DIN72: 54mm DIN96: 97mm
Enclosure style:	Panel mount to DIN42700
Enclosure material:	Grade UL94 VO
Bezel style:	Black matt DIN43802
Window:	Standard sheet glass
Terminals:	M4 captive screw clamp
Fixing:	2 corner fixing clamps with tensioning thumb screws
Mounting position:	Vertical mount to DIN16257, inclination of dial surface $\pm 15\%$
Damping time:	
Compliant with:	IEC61010-1B2001, CAT III 600V, EMC and LVD
Operating temperature:	-20°C to +55°C
Storage temperature:	-40°C to +75°C
Calibration temperature:	23°C
Relative humidity:	95% (non condensing)
Dimensions:	96DIN: 96mm high x 96mm wide x 63mm deep 72DIN: 72mm high x 72mm wide x 63mm deep
Panel cut out:	DIN96: 92mm x 92mm DIN72: 68mm x 68mm
IP protection:	IP40
Weight:	E243-02E 275g E243-02Q 300g E244-02E 360g E244-02Q 390g



## Connections

### AC Ammeters with Selector Switch

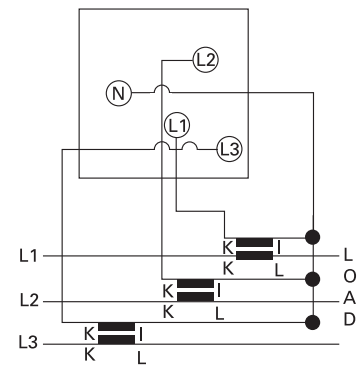

## Dimensions

### 72DIN Models

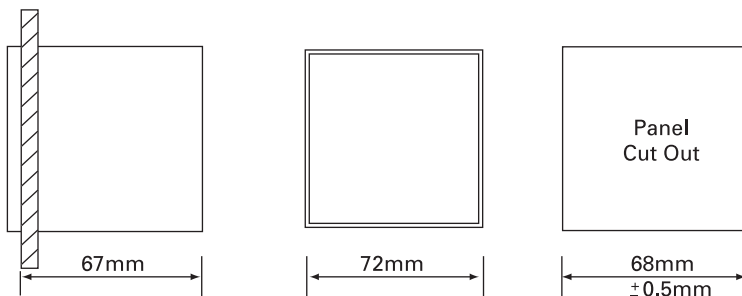

### 96DIN Models

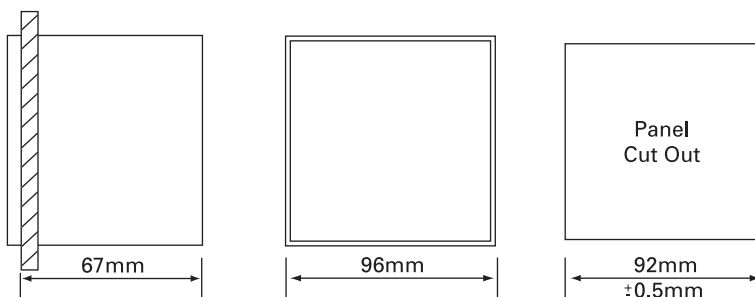

### AC Voltmeters 3-phase 3-wire

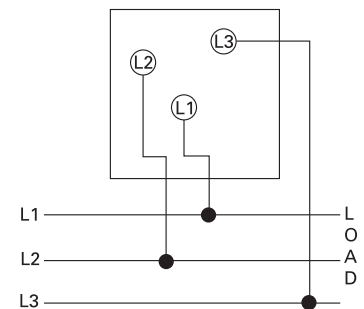

### AC Voltmeters 3-phase 4-wire

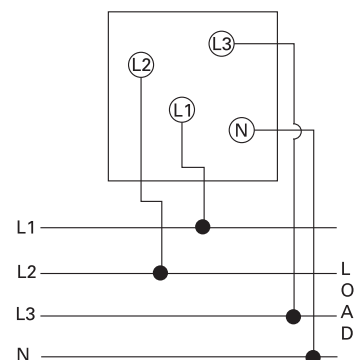

## DIN Panel Meters – Long Scale

A range of 72mm and 96mm DIN style panel meters measuring all electrical parameters and featuring moving coil movements. All meters incorporate slide-in dials and terminal covers as standard. A range of customised options is available.

### Movements

#### Moving Coil Meter

Centre cored, self shielding moving coil movement, using pivots, hairsprings and sprung jewels. Seven variations have been designed in movement ranges: all intermediate ranges are achieved by shunting the next lowest range. All DC voltmeters are 1000 ohms per volt, rectified product run at 900 ohms per volt. Millivolt meters use the 5 milliamp movement.

#### Frequency Meter

Meter uses a 100 microamps 4000 ohm movement driven by an EMC hard frequency conversion circuit.

#### Dials, Scales and Pointers

Standard dials are white matt with black printed scales and bar knife-edge pointers. Black dials with white or yellow scales and pointers are also available. Interchangeable slide-in dials are used on the E243 and E244 240° moving coil and frequency meter models.

Standard options include red supplementary pointers, and non-reflecting glass.

### Features

- A range of the most popular long scale measuring instruments in 2 case sizes
- Shock resistant sprung pivot and jewel movement
- Terminal covers supplied as standard
- EMC hard frequency meter are fully EMC and LVD compliant

### Benefits

- Local indication
- Ease of installation
- Minimal training
- Low maintenance
- Customised options and features

### Applications

- Switchgear
- Distribution systems
- Generator sets
- Control panels
- Energy management
- Building management
- Utility power monitoring
- Process control
- Motor control



## General Specifications

Performance:	BSEN60051
Measuring ranges:	DIN43701
Accuracy overload:	BSEN60051
Dimensions:	DIN43700
Scale marking generally to:	DIN43802
Magnetic influence:	BSEN60051
Safety:	BSEN61010-1
Terminals:	Clamp strap M4 for up to 25A. Clamp strap M8 for over 25A
Humidity range:	Up to 75% RH (non condensing)
Test voltage @50Hz:	3kV RMS for 1 minute
Overload AC current:	x 1.2 continuous, or x 10 for 5 seconds max
AC voltage and frequency:	x 1.2 continuous, or x 2 for 5 seconds max
Standard calibration:	23°C. Calibration at other temperatures available on request
Operating temperature:	-10°C to +55°C
Damping time:	Less than 3 seconds
Enclosure code:	IP52 as standard IP54 on request
Case and base:	Grade UL94V0 (Lexan 500R)
Case:	Dimensions and panel cut out conform to IEC473, DIN43700. Case made from glass filled polycarbonate self-extinguishing and non drip in accordance with UL94V-O
Bezel:	Slim-line DIN43802, black as standard
Bezel window:	Standard sheet glass, with zero adjusters where appropriate. Non reflecting glass windows are available
Installation;	Installations in switchboard panel or mosaic arrangement on equipment or machine with a panel thickness of up to 40mm in a horizontal or vertical plane
Fixing on panel:	Swivel captive fasteners, which can be fixed at either corner
Mounting position:	Normal vertical mounting or as indicated on the scale in accordance with DIN16257. A deviation of $\pm 15^\circ$ is permissible
Insulation group:	Insulation resistance more than $5M\Omega$ @ 500V
Environmental:	Measurement category III IEC 1010-1 Pollution degree 2 IEC 1010-1 Electrical rating 600V RMS (920V peak)
Approvals:	EMC and LVD

## DIN16257 symbol meaning for calibration position

Vertical



Horizontal



Inclined

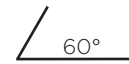

Inclination of dial surface.

Required orientation must always be stated when ordering if other than vertical mounting is required.

## Dimensions

### Moving coil measuring range

6-60A	C=67mm
>60A	C=78mm

## Dimensions

D	A	B
72 x 72mm	68 x 68mm	4
96 x 96mm	92 x 92mm	4

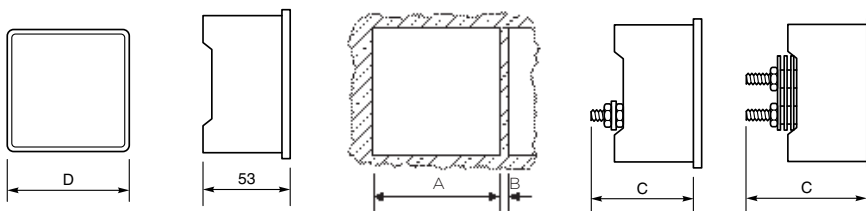



## Long Scale Moving Coil AC Ammeters and Voltmeters

Moving coil rectified instruments measure average values of sinusoidal waveforms and are scaled in RMS values.

### Specifications

AC Ammeter inputs	AC Voltmeter inputs
0/1A AC	0/60V AC
0/1.2A AC	0/100V AC
0/5A AC	0/120V AC
0/6A AC	0/125V AC
0/10A AC	0/140V AC
	0/150V AC
	0/250V AC
	0/300V AC
	0/400V AC
	0/500V AC
	0/600V AC

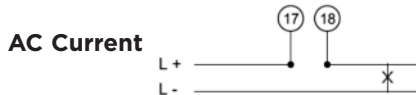
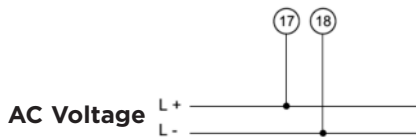

Accuracy:	Class 1.5
Frequency:	50/60Hz
Impedance:	Ammeters: 75mV internal shunt Voltmeters: 900 ohm/V

### Dimensions

Bezel size mm	72	96
Scale length mm	65	94
<b>Product codes</b>		
AC Ammeters	E243-05B	E244-05B
AC Voltmeters	E243-05W	E244-05W



## Long Scale Frequency Meters

Frequency meters use an integral electronic convertor and a moving coil indicator.

### Specifications

Voltage inputs	Frequency inputs
100/125V AC	45/55Hz
200/250V AC	45/55Hz
380/400V AC	45/55Hz
100/125V AC	55/65Hz
200/250V AC	55/65Hz
380/400V AC	55/65Hz

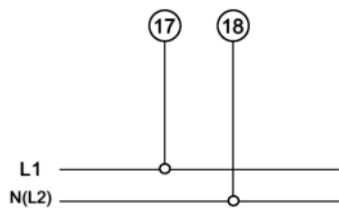

Accuracy:	Class 0.5
Burden:	<7VA

### Dimensions

Bezel size mm	72	96
Scale length mm	65	94
<b>Product codes</b>		
Frequency meter	E243-41L	E244-41L

## Long Scale Moving Coil DC Ammeters and Voltmeters

Moving coil meters are suitable for all DC systems. The linear scale is calibrated down to zero and the accuracy maintained down to 10%. Suppressed and centre zero models are available.

### Specifications

DC Ammeter inputs	DC Voltmeter inputs
0/400uA DC	0/50mV DC
0/600uA DC	0/60mV DC
0/1mA DC	0/75mV DC
0/10mA DC	0/100mV DC
0/20mA DC	0/150mV DC
0/1A DC	0/2.5V DC
0/2.5A DC	0/10V DC
0/5A DC	0/30V DC
500/0/500uA DC	0/60V DC
1/0/1mA DC	0/100V DC
20/0/20mA DC	0/150V DC
4/20mA DC	0/250V DC
	0/300V DC
	0/400V DC
	0/500V DC
	0/600V DC
	50/0/50mV DC
	60/0/60mV DC
	75/0/75mV DC
	100/0/100mV DC
	150/0/150mV DC
	5/0/5V DC
	10/0/10V DC

Accuracy:	Class 1.5
Impedance:	Ammeters: 75mV internal shunt Voltmeters: 1000Ω/V

### Dimensions

Bezel size mm	72	96
Scale length mm	65	94

### Product codes

Ammeters	E243-05A	E244-05A
Ammeters centre zero	E243-05C	E244-05C
Ammeters suppressed zero	E243-05R	E244-05R
Voltmeters	E243-05V	E244-05V
Voltmeters centre zero	E243-05N	E244-05N



# Elapsed Time Meters (Hours Run Meters)

Elapsed time meters (ETM) or hours-run meters monitor "ON/RUN" time of plant and equipment, allowing the user to effectively control production efficiency, cost estimation and service period monitoring for preventative maintenance. Time is measured in increments of 0.01h up to 99999.99 hours after which the meter automatically resets to zero. Meters are non-resettable before this time to prevent accidental resetting.

## Specifications

<b>AC</b>	
Display:	99999.99
Voltage:	100-125V AC 200-250V AC 380-440V AC
Frequency:	50 or 60Hz
Operating temperature:	-25°C to +80°C
IP Protection:	IP52
Burden:	1VA (100-125V AC) 2VA (200-250V AC) 3.5VA (380-440V AC)
<b>DC</b>	
Display:	99999.99
Voltage:	12-36V DC 10-80V DC 110V DC
Operating temperature:	-20°C to +70°C
IP Protection:	IP52
Burden:	0.5VA (12-36V AC) 1VA (10-80V AC) 1.5VA (110V AC)

### Elapsed Time/Hours Run Meters AC

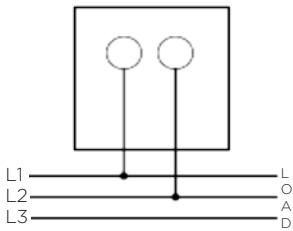

### Elapsed Time/Hours Run Meters DC

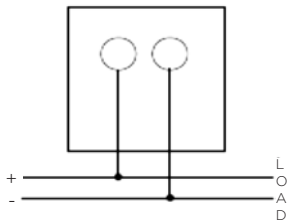

Bezel size product codes	48mm	72mm	96mm
100-125V AC 50Hz	M242-155-G-PL-ZH-C5	M243-155-G-PL-ZH-C5	M244-155-G-PL-ZH-C5
200-250V AC 50Hz	M242-155-G-RN-ZH-C5	M243-155-G-RN-ZH-C5	M244-155-G-RN-ZH-C5
380-440V AC 50Hz	M242-155-G-RY-ZH-C5	M243-155-G-RY-ZH-C5	M244-155-G-RY-ZH-C5
100-125V AC 60Hz	M242-156-G-PL-ZH-C6	M243-156-G-PL-ZH-C6	M244-156-G-PL-ZH-C6
200-250V AC 60Hz	M242-156-G-RN-ZH-C6	M243-156-G-RN-ZH-C6	M244-156-G-RN-ZH-C6
380-440V AC 60Hz	M242-156-G-RY-ZH-C6	M243-156-G-RY-ZH-C6	M244-156-G-RY-ZH-C6
12-36V DC	M242-157-G-BU-ZH-DC	M243-157-G-BU-ZH-DC	M244-157-G-BU-ZH-DC
10-80V DC	M242-157-G-NR-ZH-DC	M243-157-G-NR-ZH-DC	M244-157-G-NR-ZH-DC
110V DC	M242-157-G-PM-ZH-DC	M243-157-G-PM-ZH-DC	M244-157-G-PM-ZH-DC

## Moving Coil Dual AC Ammeters & Voltmeters

Dual instruments can be used to measure a wide range of currents and voltages, and save both space and time by requiring only one panel cut out. The E244-80L allows for independent measurement of two AC voltages in one case. The E244-80F allows for independent measurement of two AC currents in one case.

### Specifications

AC Ammeter inputs	AC Voltmeter inputs
0/1A AC	0/120V AC
0/1.2A AC	0/150V AC
0/5A AC	0/300V AC
0/6A AC	0/500V AC
0/10A AC	0/600V AC

Accuracy:	Class 1.5
Frequency:	50/60Hz
Impedance:	Ammeters: 75mV internal shunt Volts: 900 ohm/V

### Dimensions

Bezel size mm	96
Scale length mm	94
<b>Product codes</b>	
AC Ammeters	E244-80F
AC Voltmeters	E244-80L

## Dual Frequency Meters

Dual frequency instruments can be used to measure a wide range of frequencies, and save both space and time by requiring only one panel cut out. The E244-41D allows for independent measurement of two AC frequencies in one case.

### Specifications

Voltage inputs	Frequency inputs
100/125V AC	45/55Hz
200/250V AC	45/55Hz
380/400V AC	45/55Hz
100/125V AC	55/65Hz
200/250V AC	55/65Hz
380/400V AC	55/65Hz

Accuracy:	Class 0.5
Burden:	<7VA

### Dimensions

Bezel size mm	96
Scale length mm	94
<b>Product codes</b>	
Frequency meters	E244-41D



### Connections

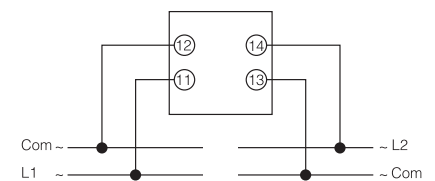

### Connections

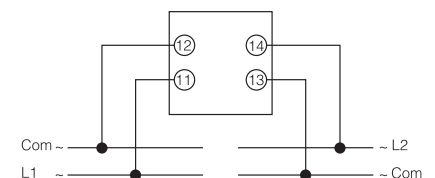

## Phase Sequence Indicators

Electronic phase sequence indicators ensure correct phase rotation and the presence of all 3-phase supplies. Incorrect or loss of phase can cause serious damage in a wide range of electrical machines. Ship-to-shore supplies, mobile generators and remote installations are particularly vulnerable to this problem.



Voltage:	151/300V, 301/500V 100/150V (Model 244-12P only)
Frequency:	50/60Hz
Burden:	2.5VA/phase

### Dimensions

Bezel size mm	72	96
<b>Product codes</b>		
Phase sequence indicator	243-12P	244-12P

### Connections

#### Phase Sequence Indicators

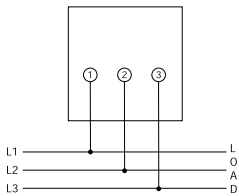



# Phase Angle Meters

## Electronic Phase Angle Meters

Phase angle meters indicate the phase displacement between current and voltage. They are used in applications where the phase angle must be monitored, for example with tariffs having VAR penalties, or to optimise generator power delivery.

### Specifications

Accuracy:	Class 1.5
Ratings:	Current: 1A or 5A for CTs
	Voltage: 110V, 240V, 380V & 400V for VT use
Frequency:	50Hz, 60Hz
Burden at 50Hz:	Current: 1VA
	Voltage: 3VA per phase
Current range:	20-120%

### Product Codes - Short-Scale Models Dimensions

Bezel size mm	72	96
Scale length mm	65	94
<b>Product codes</b>		
3-phase 3/4-wire balanced load	E243-42A	E244-42A



### Connections

#### 3-phase, 3-4-wire Balanced Systems

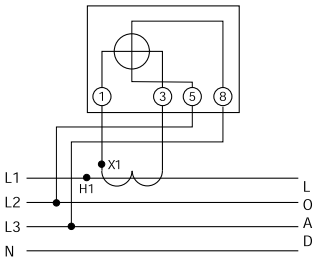
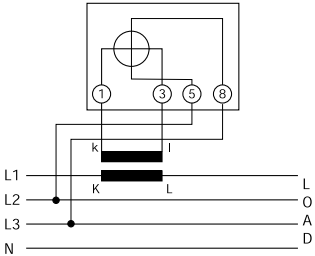



## Power Factor

Power Factor indicators are suitable for generators or supplies operating in parallel. The scale calibrated  $\cos 0.5 - 1 - 0.5$  indicates power low for inductive and capacitive loads.

### Specifications

#### Voltage inputs

1-phase	3-phase 3-wire	3-phase 4-wire
63.5V AC	110V AC L/L	63.5V AC L/N
100V AC	120V AC L/L	69.3V AC L/N
110V AC	220V AC L/L	127V AC L/N
120V AC	230V AC L/L	132.7V AC L/N
220V AC	240V AC L/L	139V AC L/N
230V AC	380V AC L/L	220V AC L/N
240V AC	415V AC L/L	240V AC L/N
380V AC	440V AC L/L	254V AC L/N

#### Current inputs

1A AC	1A AC	1A AC
5A AC	5A AC	5A AC

### Single-phase

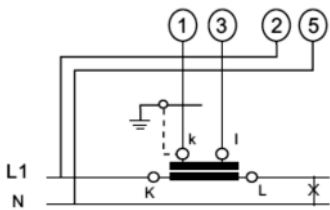

### Three Phase Balanced Load

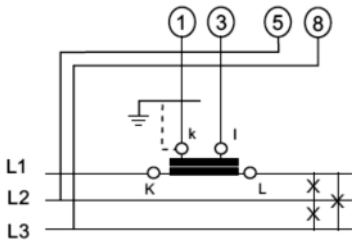

Accuracy:	Class 1.5
Measuring ranges:	Voltage: 85-115%
	Current: 20-120%
Overload:	120% of rated voltage & current continuous
Max Input:	600V
Frequency:	50/60Hz (45-65Hz max)
Burden:	Current: $\leq 0.2VA$ per phase
	Voltage: $\leq 1VA$ per phase

### Dimensions

Bezel size mm	96
Scale length mm	94

### Product codes

1-phase	E244-135
3-phase 3-wire balanced load	E244-136
3-phase 4-wire balanced load	E244-13D

# LED Synchroscope

## 360° LED Synchroscope and Synchro Check Relay

Where manual parallelling of two AC systems is desired, the frequency of both systems can be monitored by an LED synchroscope. The systems are synchronised when the green LED is lit in the 12 o'clock position. The instrument is rated for continuous operation and connection. For the semi-automatic parallelling of two AC systems, the voltage, phase displacement and the frequency of both systems can be monitored by this LED synchroscope and synchro check relay. Controls for voltage, phase angle, and time delay are provided. The systems are synchronised when the green triangular LEDs are lit together with the GEN/BUS green LEDs. A dead bus option is also available.

### Specifications

Ratings voltage:	63.5, 110, 120, 220, 230, 240, 380, 400, 415, 440, 480V 110/120V (115V nominal) 220/240V (230V nominal) 380/480V (430V nominal) Volts AC or via VT
Frequency:	40/65Hz
Burden at 50Hz:	4VA maximum Suitable for 1 or 3-phase systems
Safety:	IEC1010-1 (300V AC RMS installation degree 2)
Dielectric:	4kV rms for 1 minute
Isolation:	BUS/GEN/RELAY
Vibration:	To Lloyds shipping specification
*Phase difference:	+0-20°, +2%
*Voltage difference:	+0-20%, +/-2% 0-10% for models G and H
*Time delay:	0-2.5 seconds +10%
*Accuracy:	Synchronisation at T.DC is +1°

\*Only for the 360° LED synchroscope and synchro check relay.

### Dimensions

Bezel size mm	96	96	96
Scale length mm	360° LED	360° LED	360° LED
3- or 4-wire	Synchroscope	Synchroscope and synchro check	Synchroscope and synchro check relay (dead bus)
40-65Hz			

### Product codes

110/120V	-	244-14GG-POBX	244-14HG-POBX
220/240V	-	244-14GG-R5BX	244-14HG-R5BX
380/480V	-	244-14GG-RUBX	244-14HG-RUBX
63.5V	244-14AG-NXYY	244-14LG-NXBX	244-14DG-NXBX
110V	244-14AG-PMYY	244-14LG-PMBX	244-14DG-PMBX
220V	244-14AG-R4YY	244-14LG-R4BX	244-14DG-R4BX
230V	244-14AG-RQYY	244-14LG-RQBX	244-14DG-RQBX
240V	244-14AG-RRYY	244-14LG-RRBX	244-14DG-RRBX
380V	244-14AG-RUYY	244-14LG-RUBX	244-14DG-RUBX
400V	244-14AG-SCYY	244-14LG-SCBX	244-14DG-SCBX
415V	244-14AG-SBYY	244-14LG-SBBX	244-14DG-SBBX
440V	244-14AG-SHYY	244-14LG-SHBX	244-14DG-SHBX
480V	244-14AG-SEYY	244-14LG-SEBX	244-14DG-SEBX

For the 244-14L and 244-14D models, the generator voltage is compared to the nominal input (bus) voltage specified at time of ordering. For the 244-14G and 244-14H models, the generator voltage is compared to the measured bus voltage.



### Connections

#### 360° LED Synchroscope

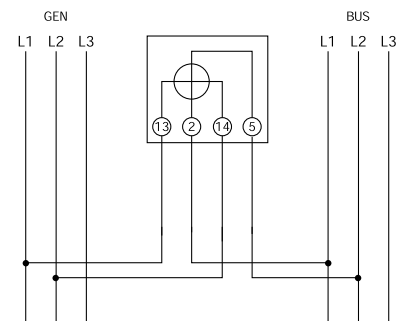

#### 360° LED Synchroscope and Synchro Check Relay

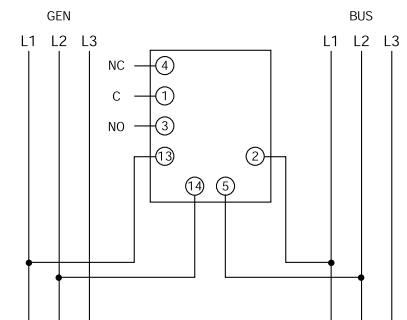

# Power

## Wattmeters & VArmeters

Self contained Wattmeters and VArmeters are able to measure active and reactive power in both balanced and un-balanced, single-, 3-phase 3-wire and 3-phase 4-wire systems. Wattmeters are ideal for clear precise analogue indication of power in applications such as power generation, industrial control and power distribution.

### Specifications

Voltage inputs		
1-phase	3-phase 3-wire	3-phase 4-wire
63.5V AC	110V AC L/L	63.5V AC L/N
100V AC	120V AC L/L	69.3V AC L/N
110V AC	220V AC L/L	127V AC L/N
120V AC	230V AC L/L	132.7V AC L/N
220V AC	240V AC L/L	139V AC L/N
230V AC	380V AC L/L	220V AC L/N
240V AC	415V AC L/L	240V AC L/N
380V AC	440V AC L/L	254V AC L/N

Current inputs		
1A AC	1A AC	1A AC
5A AC	5A AC	5A AC

Accuracy:	Class 1.5
Measuring ranges:	Voltage: 85-115% Current: 20-120%
Overload:	120% of rated voltage & current continuous
Max Input:	600V
Frequency:	50/60Hz (45-65Hz max)
Power factor:	Unity power factor assumed range 0.5/1/0.5
Burden:	Current: $\leq 0.2VA$ per phase Voltage: $\leq 1VA$ per phase

### Dimensions

Bezel size mm	96
Scale length mm	94

#### Wattmeter Product Codes

1-phase	E244-210
3-phase 3-wire balanced load	E244-211
3-phase 4-wire balanced load	E244-21C
3-phase 3-wire unbalanced load	E244-213
3-phase 4-wire unbalanced load	E244-214

#### VArmeter Product Codes

1-phase	E244-310
3-phase 3-wire balanced load	E244-311
3-phase 4-wire balanced load	E244-31C
3-phase 3-wire unbalanced load	E244-313
3-phase 4-wire unbalanced load	E244-314

### Product Codes - Long Scale

Bezel size mm	96
Scale length mm	150

#### Wattmeter Product Codes

1-phase	E244-215
3-phase 3-wire balanced load	E244-216
3-phase 4-wire balanced load	E244-21D
3-phase 3-wire unbalanced load	E244-218
3-phase 4-wire unbalanced load	E244-219

#### VArmeter Product Codes

1-phase	E244-315
3-phase 3-wire balanced load	E244-316
3-phase 4-wire balanced load	E244-31D
3-phase 3-wire unbalanced load	E244-318
3-phase 4-wire unbalanced load	E244-319

### Active Power

Single-phase  
(one element)

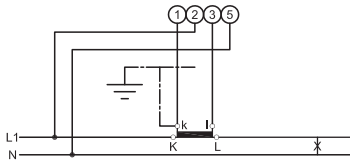

Three-phase, three-wire  
AC supply with balanced load  
(One element)

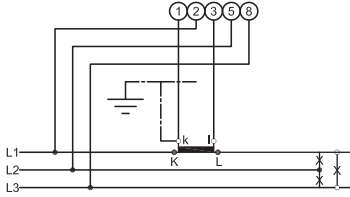

Three-phase, four-wire  
AC supply with balanced load  
(One element)

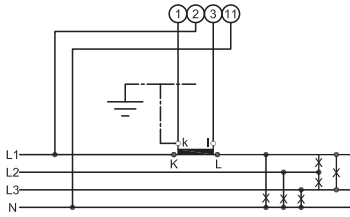

Three-phase, three-wire  
AC supply with unbalanced load  
(Two element)

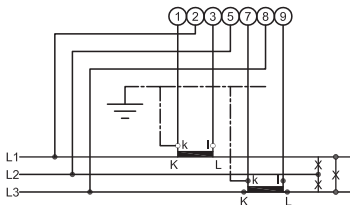

Three-phase, four-wire  
AC supply with unbalanced load  
(Three element)

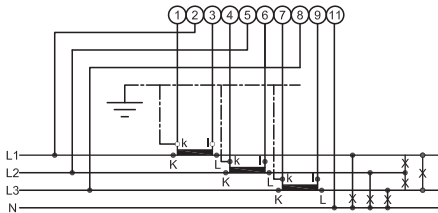

### Reactive Power

Single-phase  
(one element)

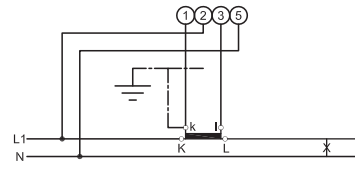

Three-phase, three-wire  
AC supply with balanced load  
(One element)

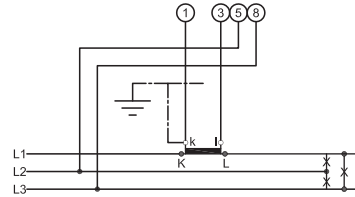

Three-phase, four-wire  
AC supply with balanced load  
(One element)

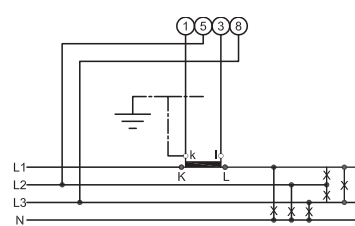

Three-phase, three-wire  
AC supply with unbalanced load  
(Two element)

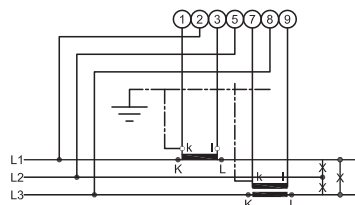

Three-phase, four-wire  
AC supply with unbalanced load  
(Three element)

