

**JAB-IN™  
FULL SIZE  
CERAMIC**

## **CERAMIC JAB-IN™ FULL SIZE THERMOCOUPLE CONNECTOR**

- **2-POLE**
- **ONE-PIECE BODY**
- **JAB-IN™ WIRE HOOK-UP**
- **CERAMIC CONSTRUCTION**  
Utilization Temperature to 1000°F(538°C)
- **SUITABLE FOR VACUUM USE**

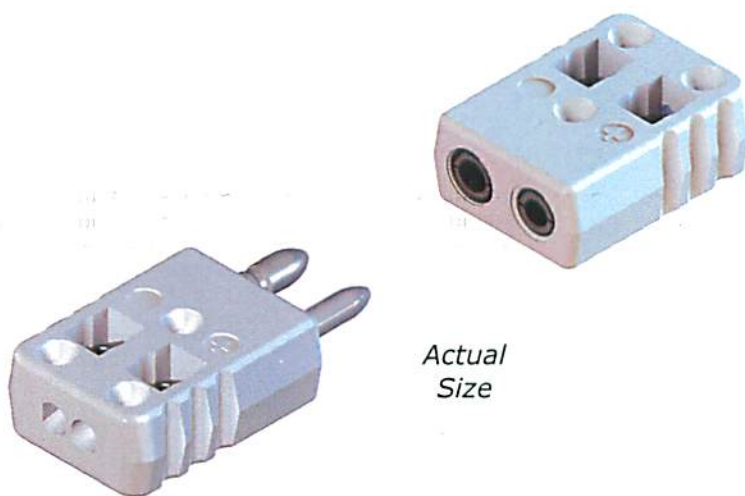

**Marlin** Manufacturing  
Corporation

© Marlin 2011

12800 Corporate Drive  
Cleveland, OH 44130

216-676-1340 800-321-6648 USA  
216-676-1344fax sales@marlinmfg.com

Wires Jab-In™ for quick reliable hook-up of wires to 14 gage (0.064"). Strip approximately 1/2"

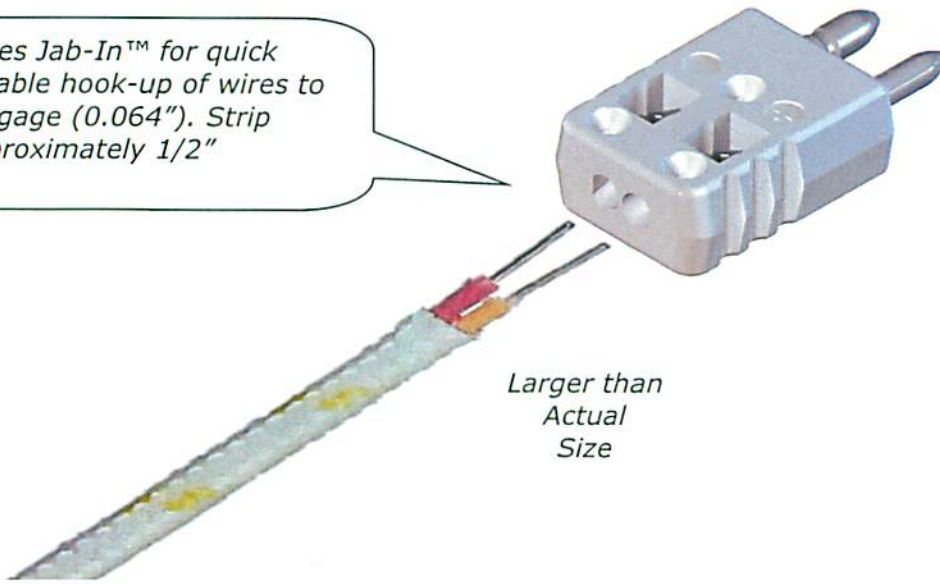

Larger than Actual Size

Standard Full-Size Mounting Hardware fits both Plug and Jack

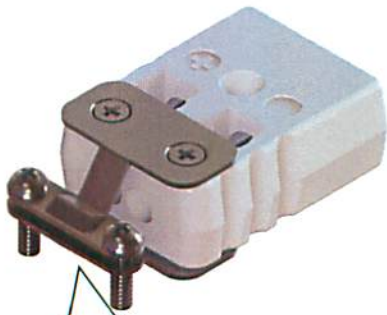

1082 Wire Clamp

Soft Insulated thermocouple alloy wire can be strain relieved and held secure via optional adapters

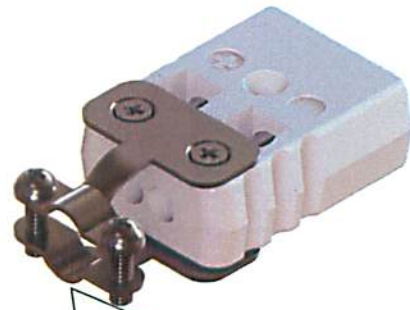

1086 Cable Clamp™



1074 Crimp Adapter

MIMS (Mineral Insulated Metal Sheath) Thermocouple can be secured via optional crimp or compression adapters

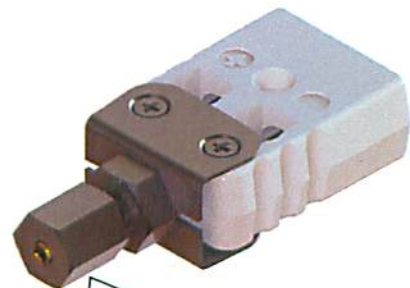

1072 Compression Adapter

## SPECIFICATIONS

## APPLICATION:

Intended for convenient plug-in connections of thermocouples and thermocouple extensions.

## PURPOSE:

To maintain the integrity of thermocouple circuits by utilizing proper thermocouple alloys and wiring techniques.

## DESCRIPTION

- 2-POLE - Conforms to ASTM E 1129 Dimensional Requirements
- STANDARD (ROUND PINS: Tubular or Solid)
- COMPATIBLE ALLOY CIRCUITRY
- ONE-PIECE BODY
- JAB-IN WIRE HOOK-UP: SS COMPONENTS ( up to 14 gage (0.064") )
- CERAMIC CONSTRUCTION
  - Utilization Continuous Use Temperature to 1000°F (538°C)  
(Limitation of Spring Contacts)
  - Intermittent Temperature Limit 1200°F (649°C)  
(Depending On Atmosphere)
  - Suitable for Vacuum use
  - Approximate Ceramic Melting Temperature (N/A—WILL NOT MELT)
- WHITE CERAMIC COLOR
- THERMOCOUPLE TYPE DESIGNATION ON BODY
- POLARITY MOLDED INTO BODY

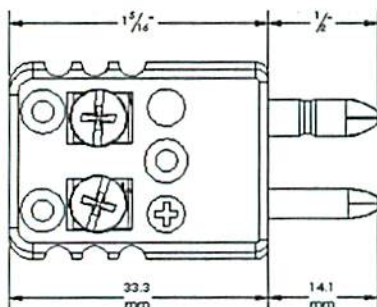

*Plug Jab-In Ceramic  
42C1XX00 Tubular Pins  
42C4XX00 Solid Pins  
XX= Type Designator*

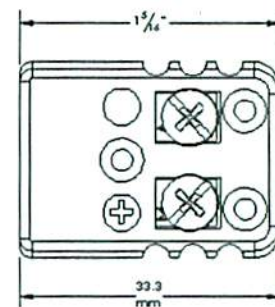
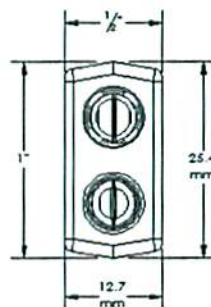

*Jack Jab-In Ceramic  
45C1XX00  
XX= Type Designator*

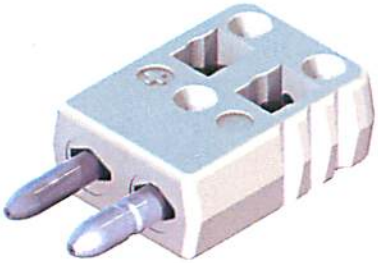
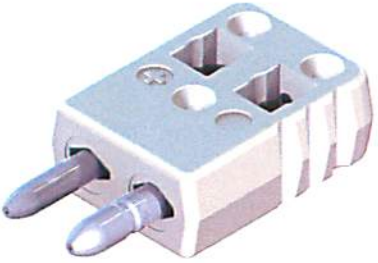
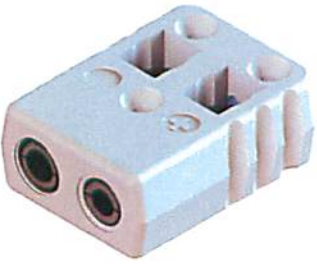
DESCRIPTION	TYPE	CODE	PRICE		
<b>PLUG CERAMIC JAB-IN</b>  	T	42C10100	\$7.25/EA		
	J	42C10200			
	E	42C10300			
	K	42C10400			
	N	42C10500			
	RX	42C10600			
	SX	42C10700			
	CX	42C11200			
	U	42C10900			
	<b>PLUG CERAMIC JAB-IN SOLID PIN</b>  	T		42C40100	\$9.25/EA
J		42C40200			
E		42C40300			
K		42C40400			
N		42C40500			
RX		42C40600			
SX		42C40700			
U		42C40900			
<b>JACK CERAMIC JAB-IN</b>  		T	45C10100	\$8.00/EA	
		J	45C10200		
	E	45C10300			
	K	45C10400			
	N	45C10500			
	RX	45C10600			
	SX	45C10700			
	CX	45C11200			
	U	45C10900			

QUANTITY	DISCOUNT
<25	NET
>25<100	0.90
>100	0.80